

## REVOLU Patio Cover

# Kunkel Works



Up to 20' Projection, Straight Edge Cover

*Straight and Rounded  
Roof-line Option  
with Bearing Beam*



Up to 15' Projection, with Bearing Beam **Maximum space between posts 18'**



Up to 12' Projection, Rounded  
Roof with Bearing Beam



See many examples of locally installed  
Patio Covers at [KunkelWorks.com](http://KunkelWorks.com)

Call TODAY: 808-955-8211 • [www.kunkelworks.com](http://www.kunkelworks.com)



# REVOLU Patio Cover



## Roof Panel Choices



**Brown Panel**



**Blue Panel**



**Frosted Panel**



**Frosted Heat-cut**



**Self-cleaning Panel**



	<b>Brown Panel</b>	<b>Blue Panel</b>	<b>Frosted Panel</b>	<b>Frosted HC</b>	<b>Self-cleaning</b>
<b>Heat-cut Ratio</b>	<b>45%</b>	<b>40%</b>	<b>16%</b>	<b>70%</b>	<b>15%</b>
<b>Visible Light</b>	<b>34%</b>	<b>20%</b>	<b>88%</b>	<b>76%</b>	<b>87%</b>
<b>UV-Ray Cut</b>	<b>100%</b>	<b>100%</b>	<b>100%</b>	<b>100%</b>	<b>100%</b>

## Metal Color Choices

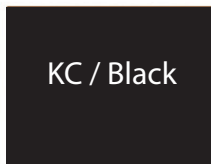
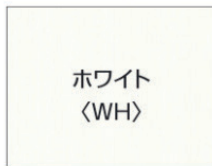

**Revolu System is available as AWNING (no Posts)  
Projections: 2', 3' or 4'**



## Roof Style Choices

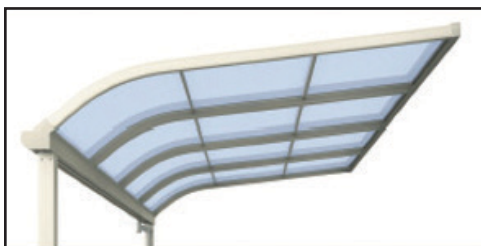

**Call TODAY: 808-955-8211 • [www.kunkelworks.com](http://www.kunkelworks.com)**



Available Fabric Shades and Side-panels

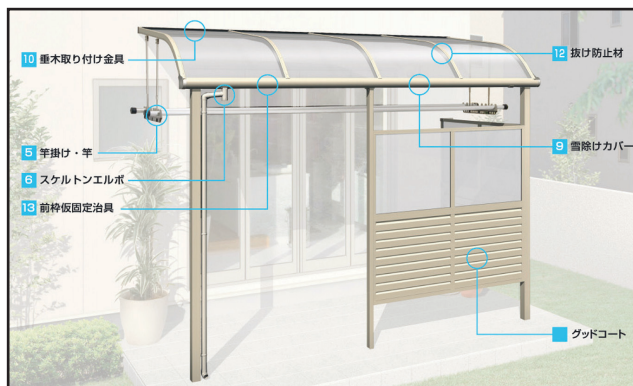

## Slope Options / Panel Support / other details

### 10 スケルトンエルボ

ゴミ詰まりが確認できるスケルトンエルボ。雨樋内部に詰まったゴミが透けて見えるスケルトンエルボをオプションでご用意。キャップの取りはずしができ、メンテナンスが簡単です。本体色に合わせて、4色から選択できます。

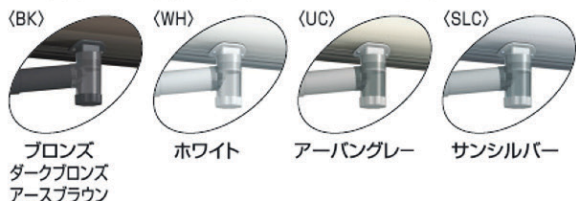

### 11 屋根角度調整タイプ<出幅移動納まり用>

屋根勾配角度を自在に調整できます。

出幅移動納まりは、「角度調整材」を垂木掛け部に取り付けることで、屋根勾配角度をフラットタイプは3°~30°、アールタイプは3°~17°まで調整することができ、軒下など障害物のある場所にも自在に対応します。

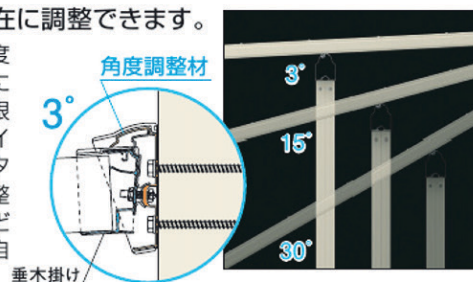

### 12 雪除けカバー

雨樋に雪が詰まらないよう、雪は下に落ちて、雨は雨樋に落ちます。落ち葉などもたまりにくくなっています。



**注** ●雪除けカバーは、すき間かくり(前面パネル用)と併用できません。

### 13 抜け防止材

強風時の屋根パネルの吹き上げを抑えます。

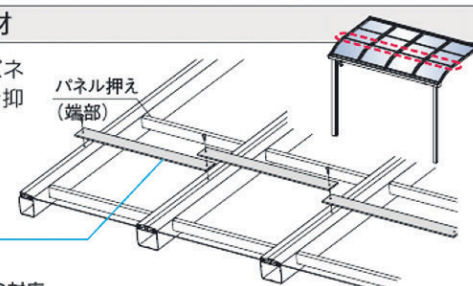

#### 抜け防止材

●間口3.0間までの対応

### 14 垂木取り付け金具<柱付き式用>

下からドライバーが入らない場合の垂木の取り付けができます。

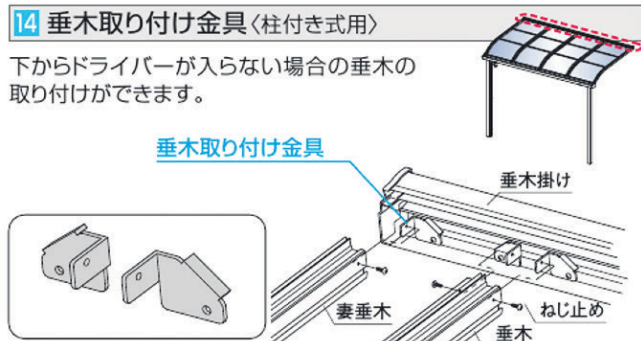

### 15 ボルトセット

テラスと屋根とのすき間が少ない場合でも簡単にボルト締めができます。

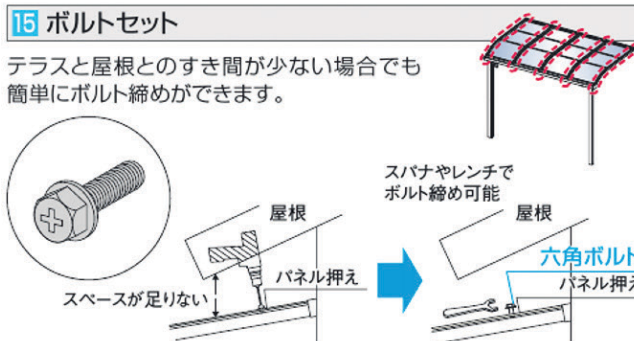



# REVOLU Side Panels

*kunkel*  
Works



■一段仕様



■二段仕様



●側面パネルは柱の任意の位置に取り付けできます。



一段仕様

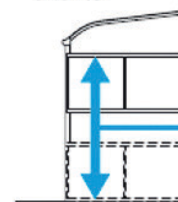

二段仕様

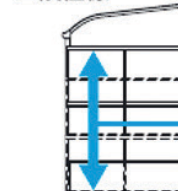

取り付け OK!!

側面パネルは必ず  
躯体柱にねじ止めし  
てください。

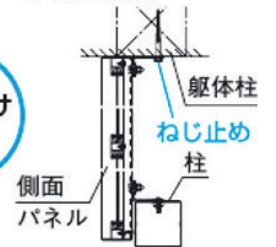

注

●側面パネルを取り付ける際は柱の位置を確認願います。



## REVOLU Patio Cover Options

出幅持ち出し納まり |R型|F型|



梁置き納まり |R型|F型|



間口張り出し納まり |R型|F型|

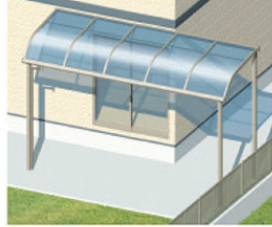

出隅納まり |R型|F型|



入隅納まり |R型|F型|

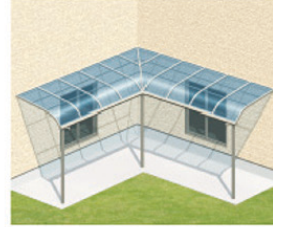

受注生産品

受注生産品

受注生産品

前面台形納まり |F型|



出幅違い納まりA |F型|

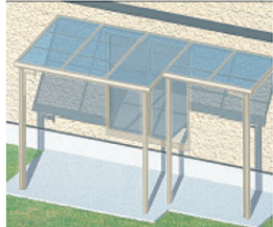

出幅違い納まりB |R型|F型|



片袖・両袖納まり |R型|F型|



傾斜連結納まり |F型|



出幅移動垂木納まり |R型|F型|



持ち出し納まり |R型|F型|



側面台形納まり(1スパン) |F型|



出隅出幅違い納まり |R型|F型|



傾斜納まり |F型|



ワイド間口フレーム |R型|F型|



自立タイプ |R型|F型|



## Load-Bearing Options

3 load bearing capacities are available. They are measured in snow-load units 20cm, 50cm and 100cm. Instead of snow, here in Hawaii the covers can carry SOLAR Panels!

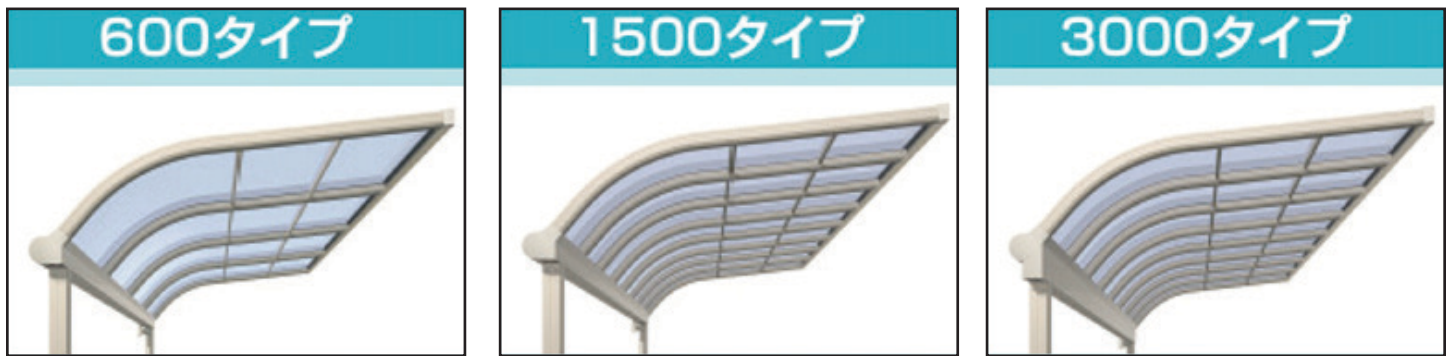

## Post Flexibility / Options

### Standard Beam - Post at Gutter

**標準納まり**



すっきりとしたデザインの標準タイプ用前桁の採用により、間口方向に柱を移動し、取り付け場所の条件に合った設置ができます。

間口内側に最大500mm、間口外側に最大60mmの移動が可能です。

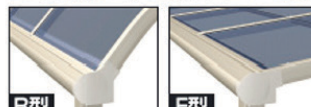

R型 F型

### Bearing Beam Option - Recessed

**出幅移動納まり**



躯体側に最大500mmの移動が可能です。

現場に応じて間口方向、出幅方向に柱を移動できるので、標準の柱位置に障害物がある場合や、躯体バルコニーへの取り付けに最適です。

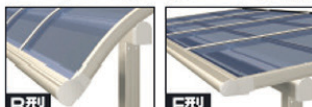

R型 F型