

REVOLU Patio Cover

Kunkel Works



Up to 20' Projection, Straight Edge Cover

*Straight and Rounded
Roof-line Option
with Bearing Beam*



Up to 15' Projection, with Bearing Beam **Maximum space between posts 18'**



Up to 12' Projection, Rounded
Roof with Bearing Beam



*See many examples of locally installed
Patio Covers at KunkelWorks.com*

Call TODAY: 808-955-8211 • www.kunkelworks.com

REVOLU Patio Cover

Roof Panel Choices



Brown Panel



Blue Panel



Frosted Panel



Frosted Heat-cut



Self-cleaning Panel

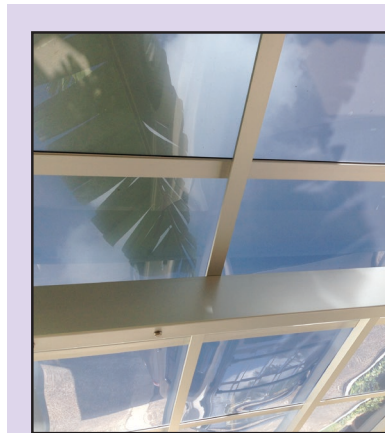

For Hawaii Customers we recommend to source the Blue Smoke Roof Panels with extra heat-cutting properties from the carports.



	Brown Panel	Blue Panel	Frosted Panel	Frosted HC	Self-cleaning	B-Smoke Heat-cut
Heat-cut Ratio	45%	40%	16%	70%	15%	83%
Visible Light	34%	20%	88%	76%	87%	11%
UV-Ray Cut	100%	100%	100%	100%	100%	100%

Metal Color Choices



ブロンズ
(BR)

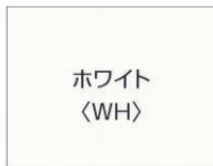

ホワイト
(WH)



ダークブロンズ
(BKC)

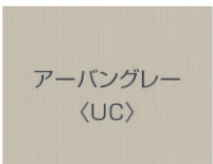

アーバングレー
(UC)

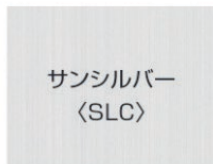

サンシルバー
(SLC)

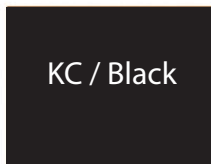

KC / Black

Revolu System is available as AWNING (no Posts)
Projections: 2', 3' or 4'



Roof Style Choices

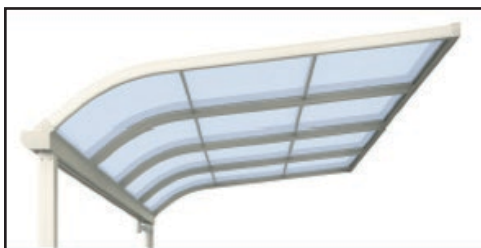



Available Fabric Shades and Side-panels

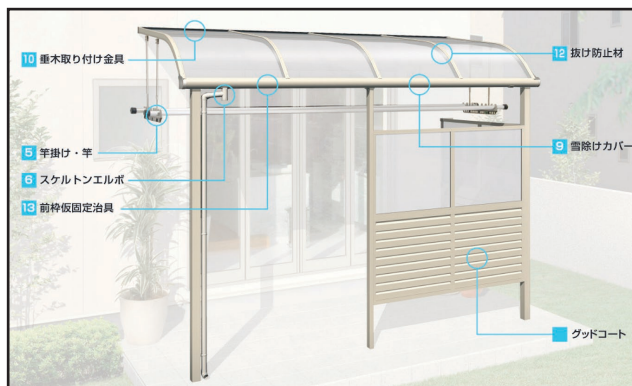

Slope Options / Panel Support / other details

10 スケルトンエルボ

ゴミ詰まりが確認できるスケルトンエルボ。雨樋内部に詰まったゴミが透けて見えるスケルトンエルボをオプションでご用意。キャップの取りはずしができ、メンテナンスが簡単です。本体色に合わせて、4色から選択できます。

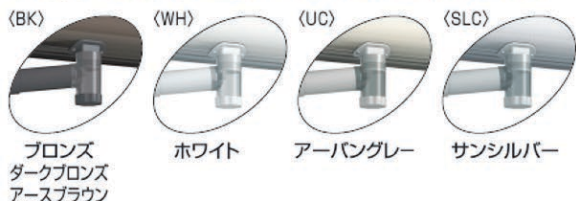

11 屋根角度調整タイプ<出幅移動納まり用>

屋根勾配角度を自在に調整できます。

出幅移動納まりは、「角度調整材」を垂木掛け部に取り付けることで、屋根勾配角度をフラットタイプは3°~30°、アールタイプは3°~17°まで調整することができ、軒下など障害物のある場所にも自在に対応します。

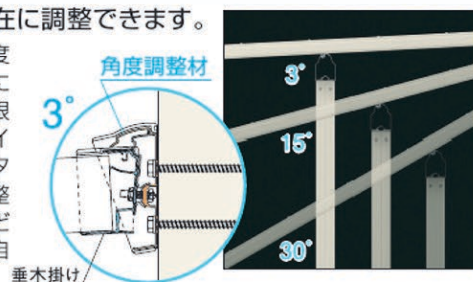

12 雪除けカバー

雨樋に雪が詰まらないよう、雪は下に落ちて、雨は雨樋に落ちます。落ち葉などもたまりにくくなっています。



注 ●雪除けカバーは、すき間かくり(前面パネル用)と併用できません。

13 抜け防止材

強風時の屋根パネルの吹き上げを抑えます。

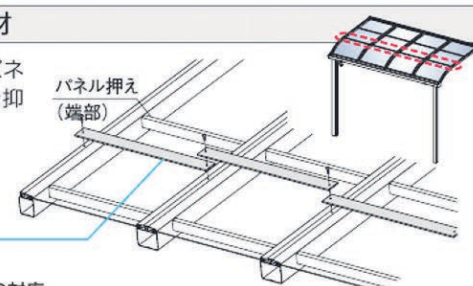

14 垂木取り付け金具<柱付き式用>

下からドライバーが入らない場合の垂木の取り付けができます。

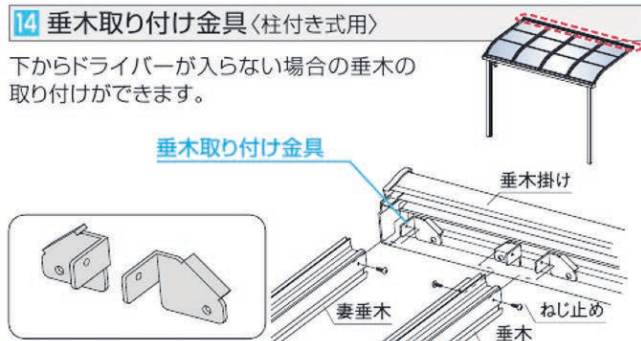

15 ボルトセット

テラスと屋根とのすき間が少ない場合でも簡単にボルト締めができます。

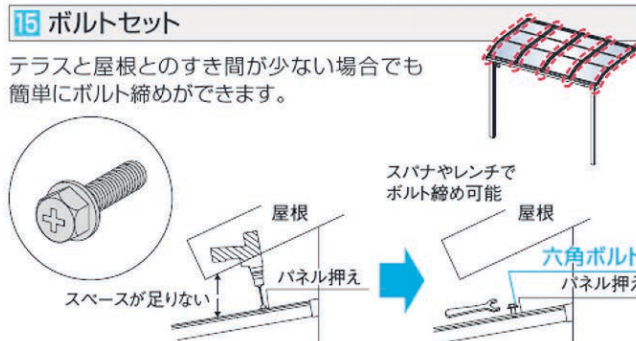

REVOLU Side Panels

kunkel
Works



■一段仕様



■二段仕様



●側面パネルは柱の任意の位置に取り付けできます。



一段仕様

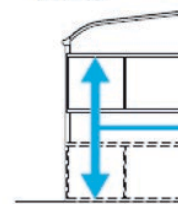

二段仕様

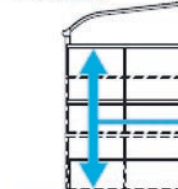

取り付け OK!!

側面パネルは必ず
躯体柱にねじ止めし
てください。

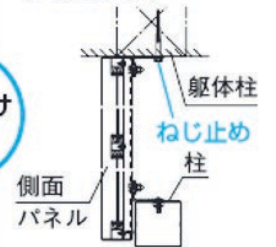

注

●側面パネルを取り付ける際は柱の位置を確認願います。

REVOLU Patio Cover Options



出幅持ち出し納まり |R型|F型|



梁置き納まり |R型|F型|

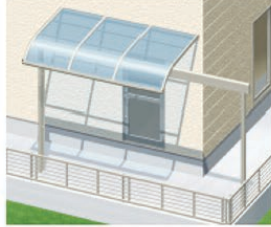

間口張り出し納まり |R型|F型|



出隅納まり |R型|F型|



入隅納まり |R型|F型|



受注生産品

受注生産品

受注生産品

前面台形納まり |F型|



出幅違い納まりA |F型|

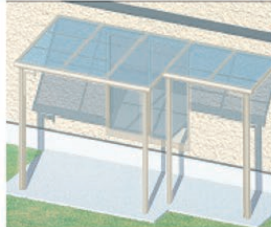

出幅違い納まりB |R型|F型|



片袖・両袖納まり |R型|F型|



傾斜連結納まり |F型|

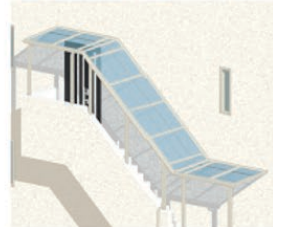

出幅移動垂木納まり |R型|F型|



持ち出し納まり |R型|F型|



側面台形納まり(1スパン) |F型|



出隅出幅違い納まり |R型|F型|



傾斜納まり |F型|



ワイド間口フレーム |R型|F型|



自立タイプ |R型|F型|



Load-Bearing Options

3 load bearing capacities are available. They are measured in snow-load units 20cm, 50cm and 100cm. Instead of snow, here in Hawaii the covers can carry SOLAR Panels!

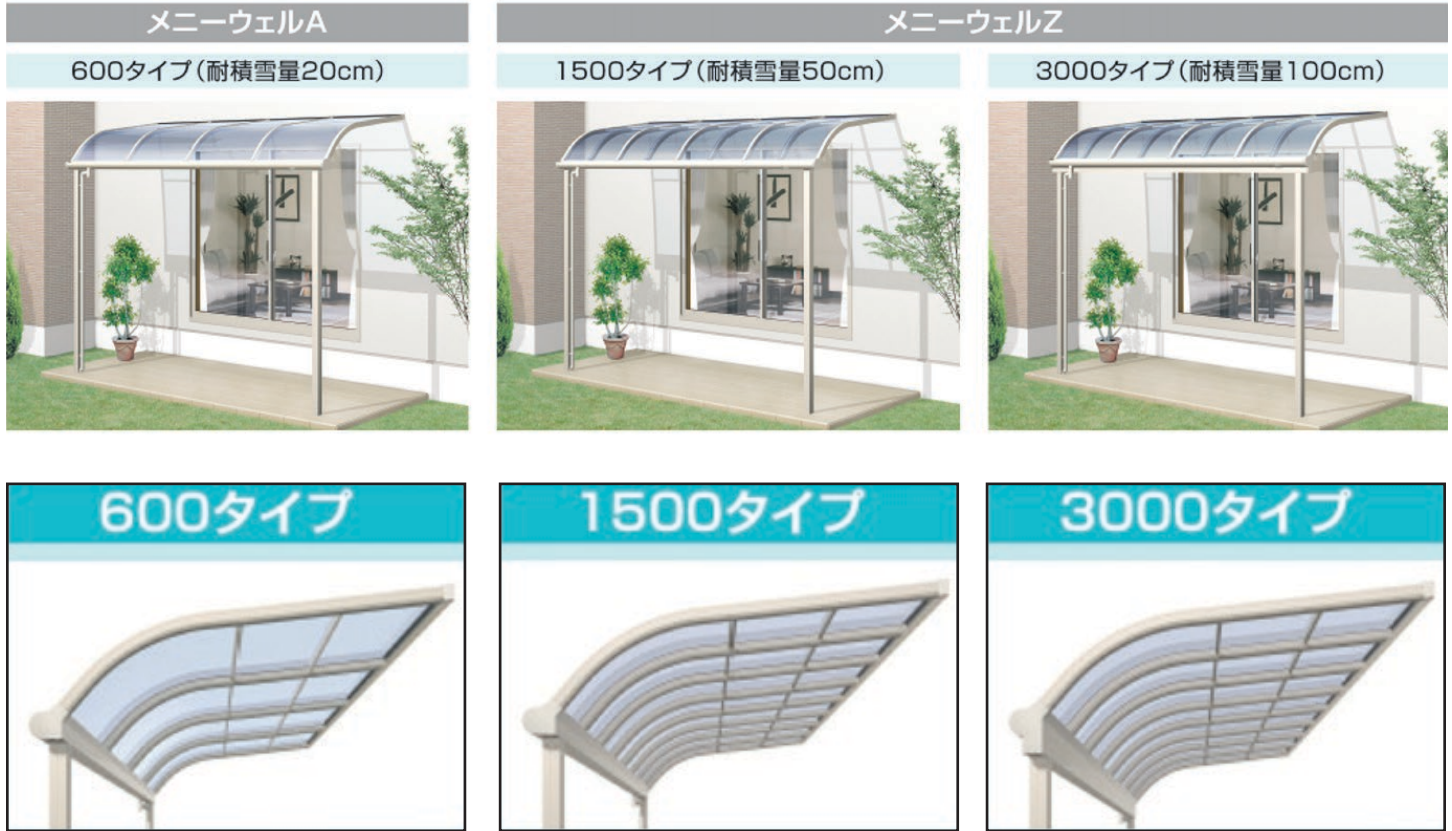

Post Flexibility / Options

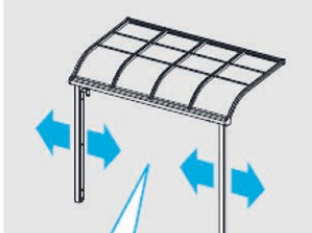

Standard Beam - Post at Gutter

標準納まり



間口内側に最大500mm、間口外側に最大60mmの移動が可能です。

すっきりとしたデザインの標準タイプ用前桁の採用により、間口方向に柱を移動し、取り付け場所の条件に合った設置ができます。

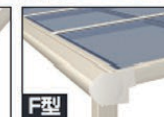
Bearing Beam Option - Recessed

出幅移動納まり



躯体側に最大500mmの移動が可能です。

現場に応じて間口方向、出幅方向に柱を移動できるので、標準の柱位置に障害物がある場合や、躯体バルコニーへの取り付けに最適です。

