

Product Details

U-Style Port Max Span 39 Feet (12 Meters)

Kunkel
Works



- *U-Style Ports feature Bearing Beams that can extend up to 39' to solve a variety of site conditions.*
- *Roof-Units can either be attached on top or suspended below providing design options.*
- *Beams and Roof-Units can be combined in multiples variations (see pages 6&7)*



Standard

*Preserve the Light
with Polycarbonate Panels*

Available in 3 Panel-types

Choose Your Roof Style

*Block out the Light
with Aluminum Panels*

Available with different color options

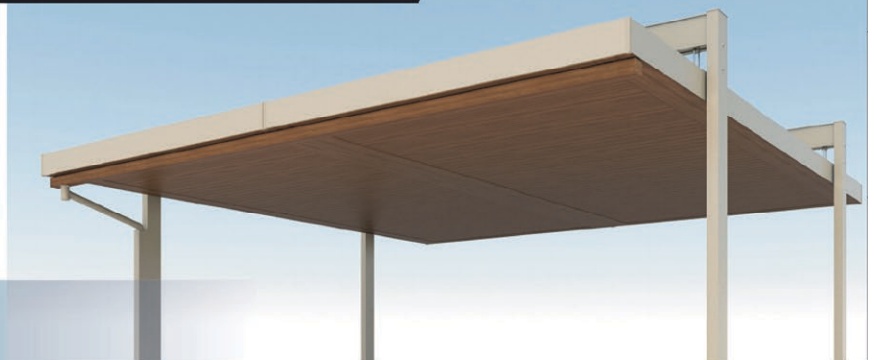

Premium

Call TODAY: 808-955-8211 • www.kunkelworks.com

U-Style - Unlimited Variations



Double Port - 4 posts

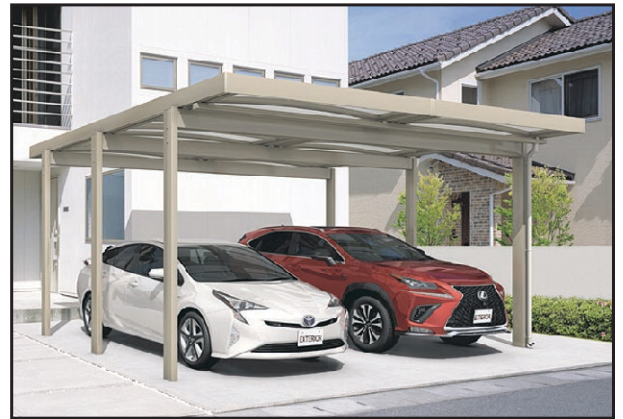

Double Port - 6 posts



Tripe Port - 4 posts



Single Port - 2 in Tandem



Roof-Units can be placed in various ways to meet site requirements

U-Style Post and Beam Options



Roof Unit Suspended from Bearing Beams



Roof Unit on Top of Bearing Beams



Roof Unit on Top of individual Posts

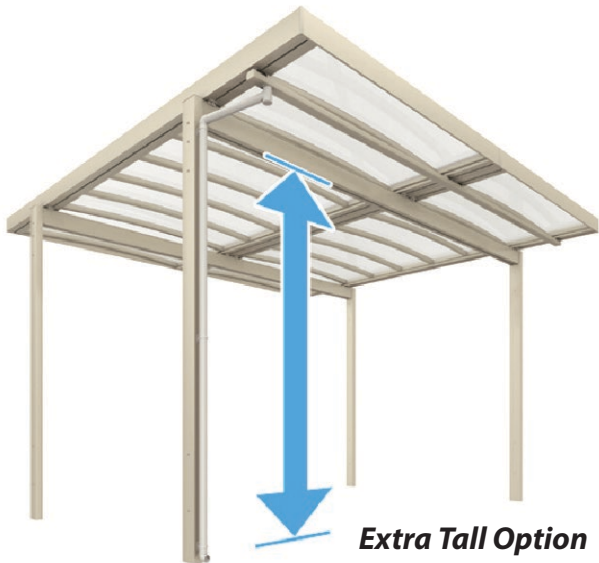
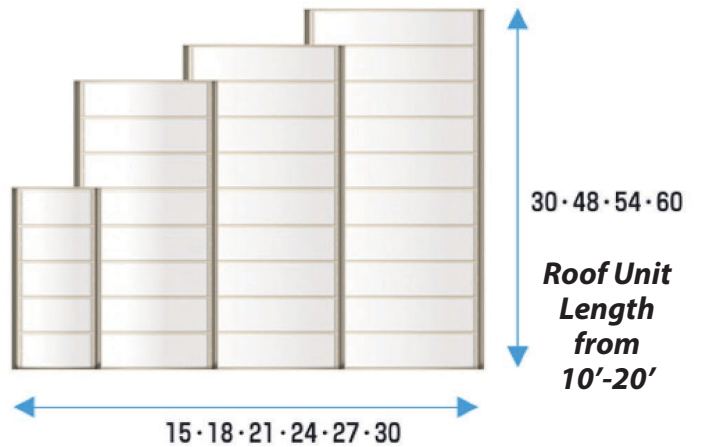

Extra Tall Option
3.5 Meters = 11.5'

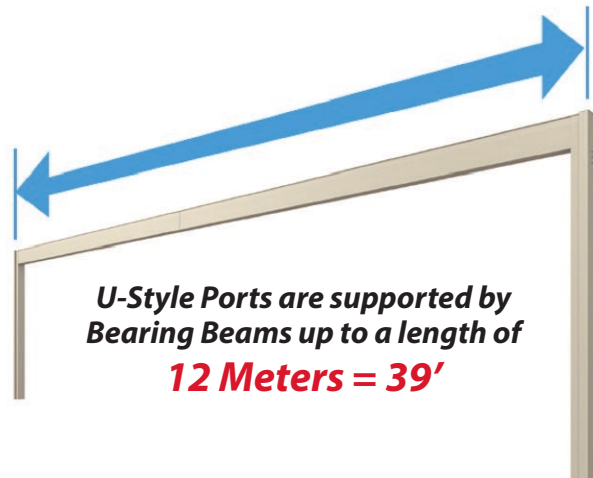

U-Style Ports are supported by Bearing Beams up to a length of 12 Meters = 39'



Double Port with Extended Bearing Beam and Wood-look Accent Color

*U-Style Ports have many
Sizes and Options*



Bearing Beams help create Entry Cover and Car-cover



Bearing Beam eliminates front post for easy access



Bearing Beams help solve difficult site conditions



Bearing Beam can extend up to 39' (no posts in middle)



U-Style Color and Panel Choices

Metal Color Choices:



2-Tone-Accent Options



屋根パネル材質			
ポリカーボネート板 (かすみ調)	熱線遮断 ポリカーボネート板	熱線遮断ポリカーボネート板 (かすみ調)	アルミ板
SI	AO	SI	UC・BD



Roof Panel Choices: **Polycarbonate** (Lexan)

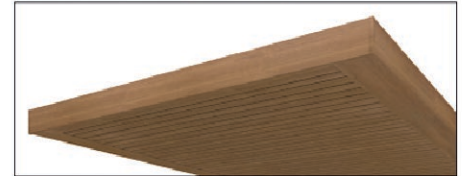
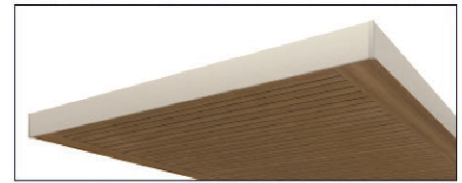
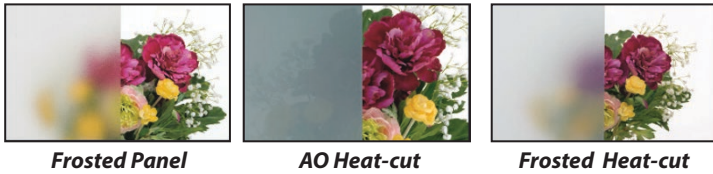

	Frosted Panel	AO Heat-Cut	Frosted HC
Heat-cut Ratio	16%	83%	70%
Visible Light	88%	11%	76%
UV-Ray Cut	100%	100%	100%

Roof Panel Choices: **Aluminum**

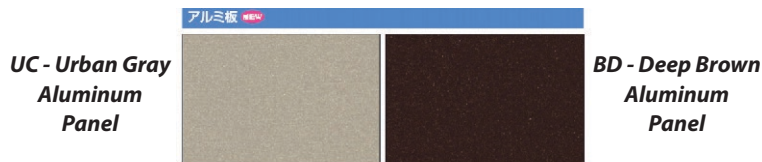

U-Style Combinations

kunkel
Works

基本納まり

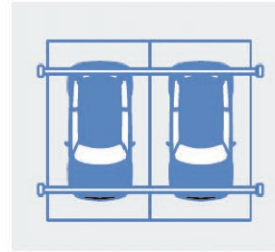

展開

A 片寄せ納まり



フレームが屋根の半分まで移動可能

フレーム位置を奥側に下げれば、車からの見通しが良く、車の出入れがしやすくなります。

注 ●片側支持タイプと両側支持タイプのDF100・120サイズ・H35(34)サイズ、耐積雪量50cm仕様は対応できません。

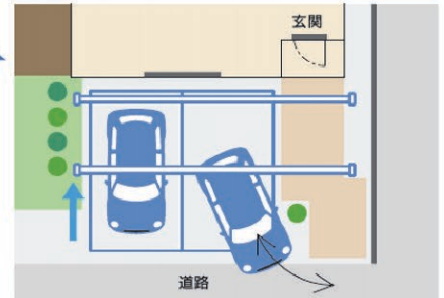

B 両端納まり



フレームが屋根の外々まで広がります

カースペースが広々とした印象になり、車への乗り降りがしやすく、玄関や前庭への動線もスムーズになります。

注 ●片側支持タイプ、奥行30サイズ、耐積雪量50cm仕様は対応できません。

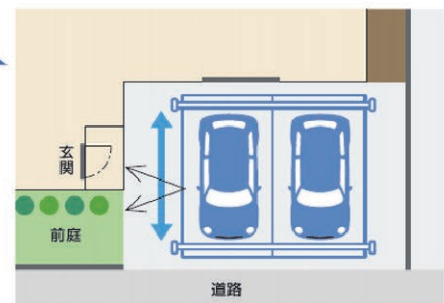

C L字納まり (片寄せ+並行納まり)



少ない柱本数でのL字納まりが可能

フレームに屋根を並行に納め、さらに片寄せ納まりと合わせて、L字のカースペースを創出。玄関・前庭・カースペースを遮る柱がなく、広々とした印象になります。

注 ●片側支持タイプ、桁取り付けタイプ、耐積雪量50cm仕様は対応できません。

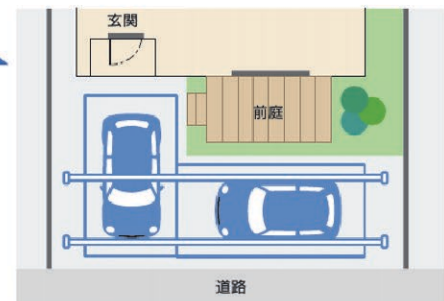

D 角度調整納まり



フレーム角度最大30°まで対応可能

前側のフレームを最大角まで移動して、車から玄関への動線をスムーズにしています。

注 ●基本納まりの移動範囲以内の場合は基本納まり用のフレーム・屋根を、移動範囲以上であればフレーム位置に合わせて片寄せ納まり用・両端納まり用をご使用ください。

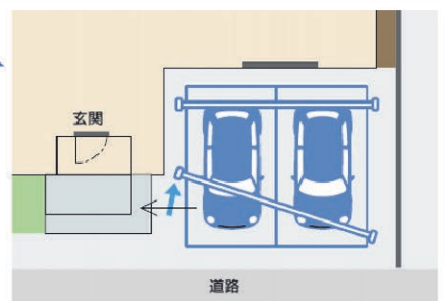

Call TODAY: 808-955-8211 • www.kunkelworks.com

U-Style Combinations

E 両側支持+片側支持納まり



両側支持と片側支持のフレームを組み合わせられます

柱を設置しにくいスペースや柱が動線の邪魔になる場合も、両側支持+片側支持フレームの組み合わせにより住まいにフィットしたプランが可能です。

注 ●桁取り付けタイプ、耐積雪量50cm仕様は対応できません。

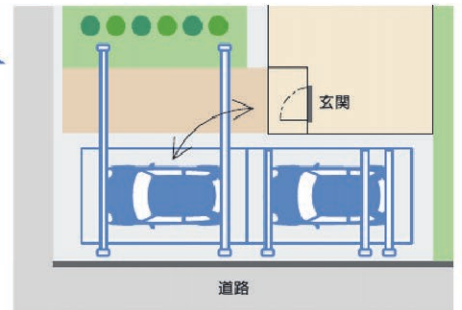

F 段差連結納まり



屋根位置をずらして連結できます

屋根部の位置をずらした連結により、前面道路とのラインや建物の形状に沿った設置ができます。

注 ●片側支持タイプ、桁取り付けタイプは対応できません。

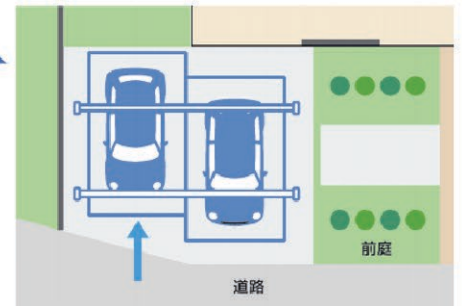

G 奥行連結納まり



屋根を奥行方向に連結できます

複数の車をたてに並べて駐車できます。限られたカースペースを有効活用できます。

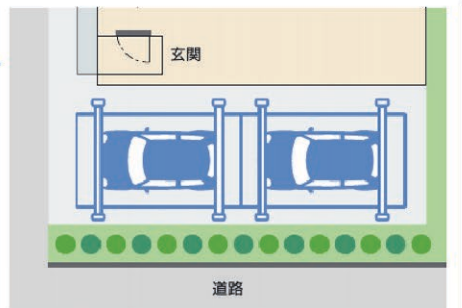

H 奥行延長納まり



小さいサイズの屋根を奥行方向に連結できます

奥行延長用の小さな屋根サイズを連結することで1台駐車でもゆとりある空間になり、自転車やバイクの駐輪スペースなどカースペース+αな使い方が可能です。

注 ●耐積雪量50cm仕様は対応できません。

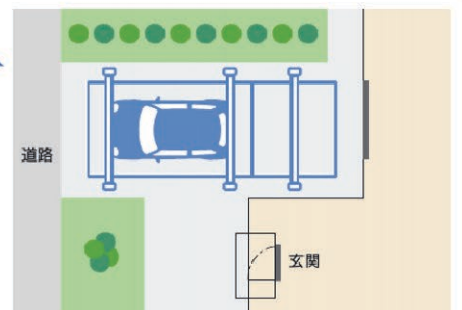

Side Panels

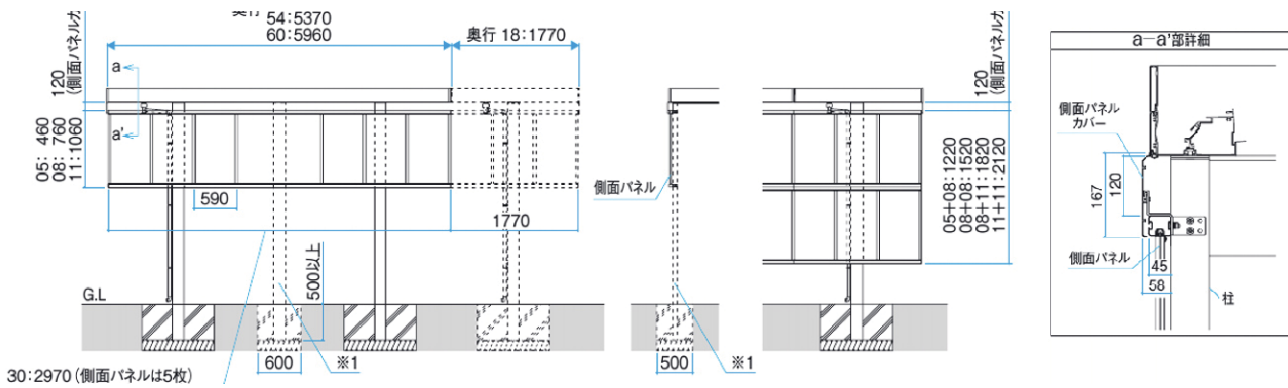

Decorative Profiles



Decorative Profiles are available in matching colors to create beautiful Entry-Designs

Single

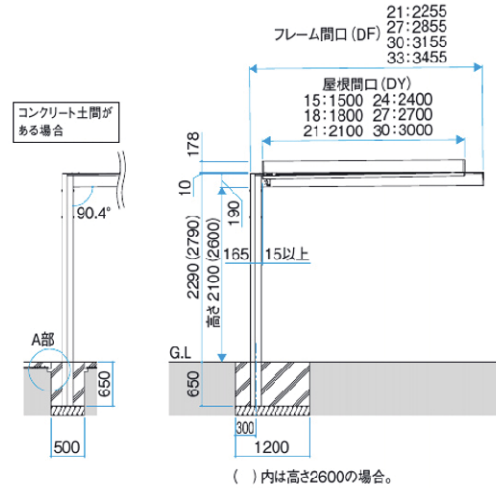
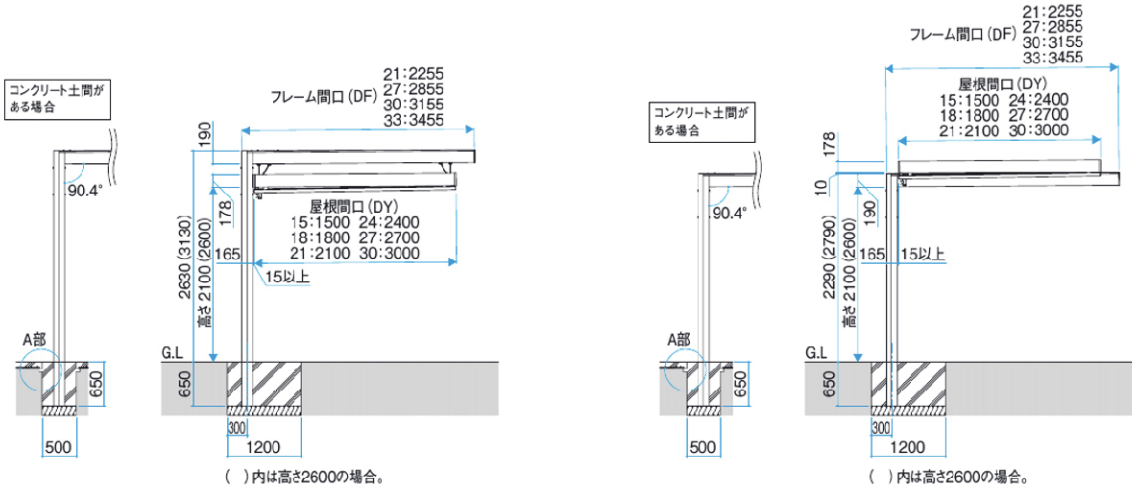

Double / Triple

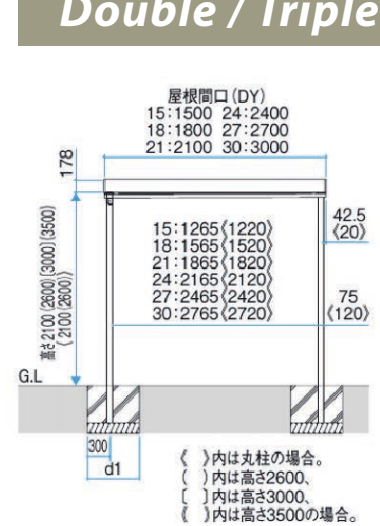
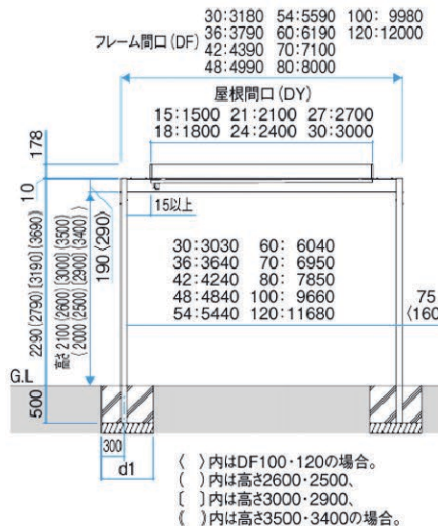
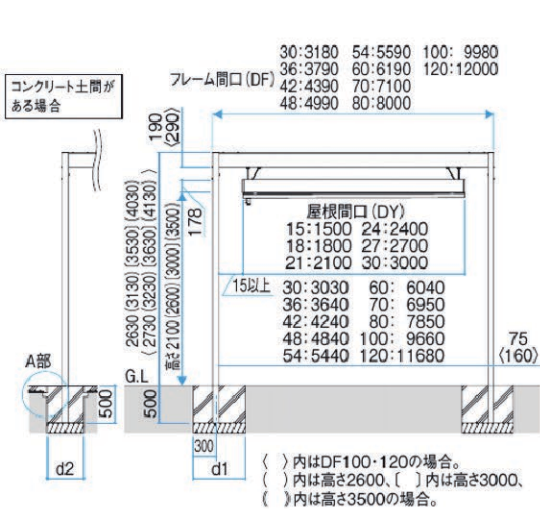

Side View

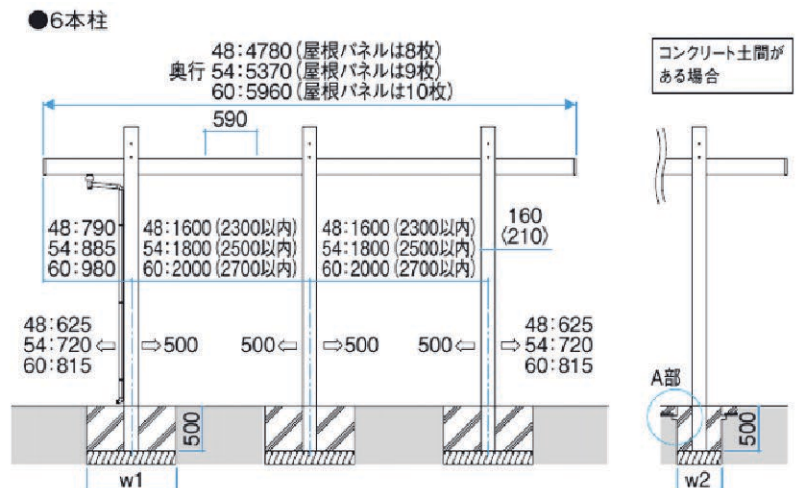
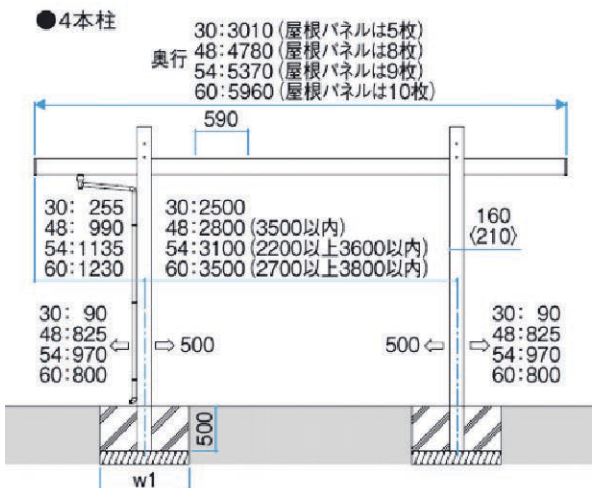

Measurements in Millimeters